



Villas

DEL CENTENARIO

A master-planned community
in the hills of El Centenario
overlooking the Sea of Cortez

July 24, 2024

About the Community

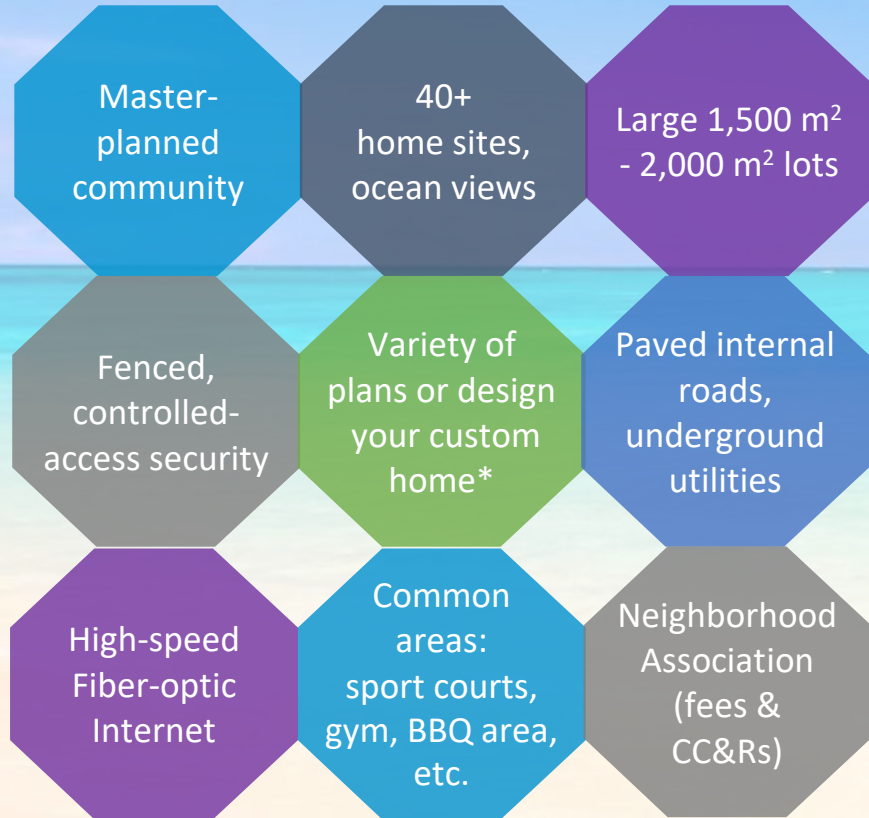

*Custom homes available in Phase III only.



Location: El Centenario, La Paz, BCS

10

Minutes to shopping centers
(Walmart, Home Depot, Sam's Club)

20

Minutes to downtown La Paz & Malecon

15

Minutes to El Mogote beach



Expat-friendly community



Miles of nearby hiking, biking &
UTV/ATV trails



Local, family-owned businesses
(restaurants, shops, services)

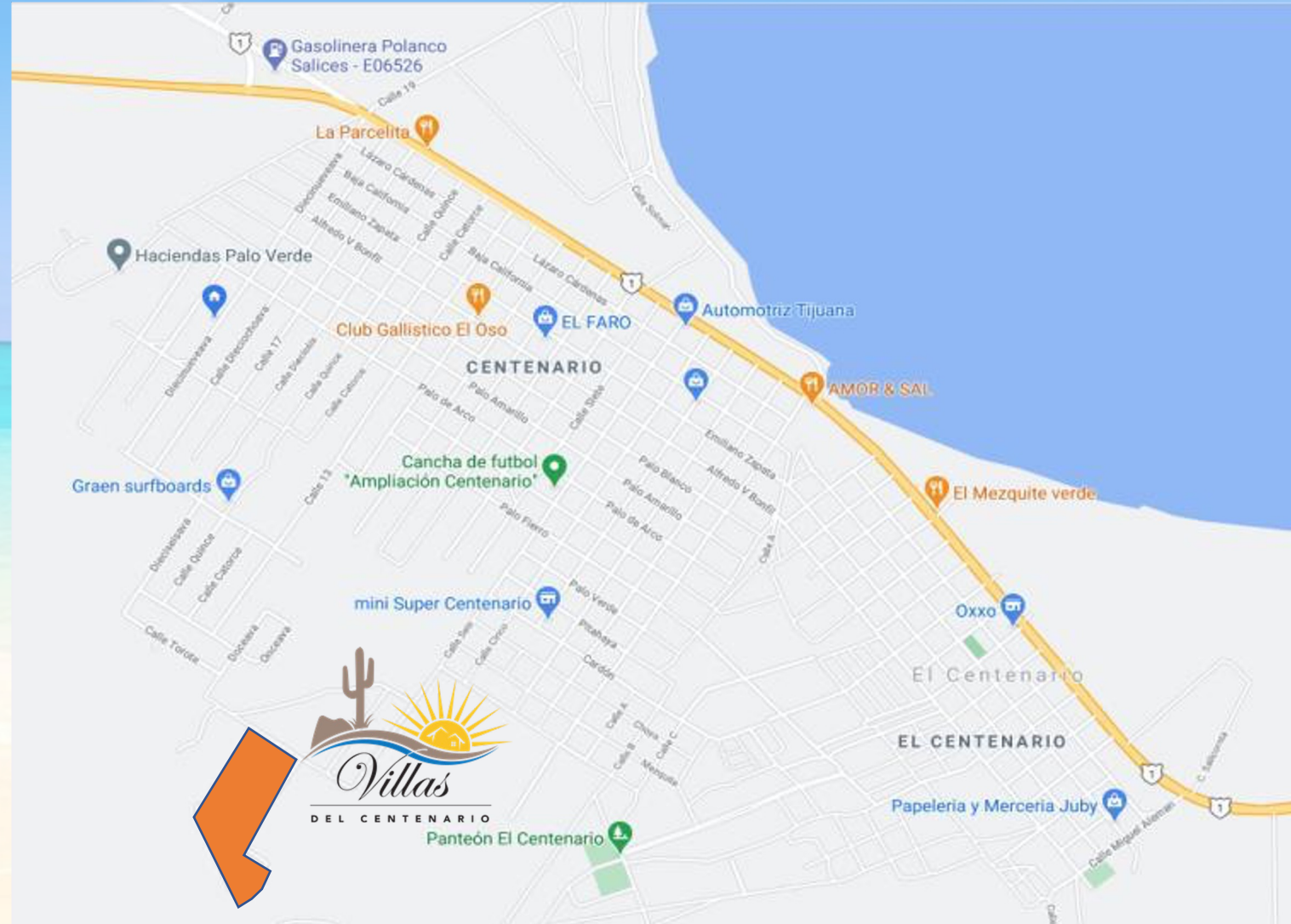

Community Development Plan

Open Now

2 lots available from \$149,000 USD

Future

7 lots, pricing TBD

PHASE I

PHASE II

PHASE III

PHASE IV

Open Now

Open 1Q 2025

6 lots available from \$109,000 USD

10 lots available from \$135,000 USD

2 spec homes in progress

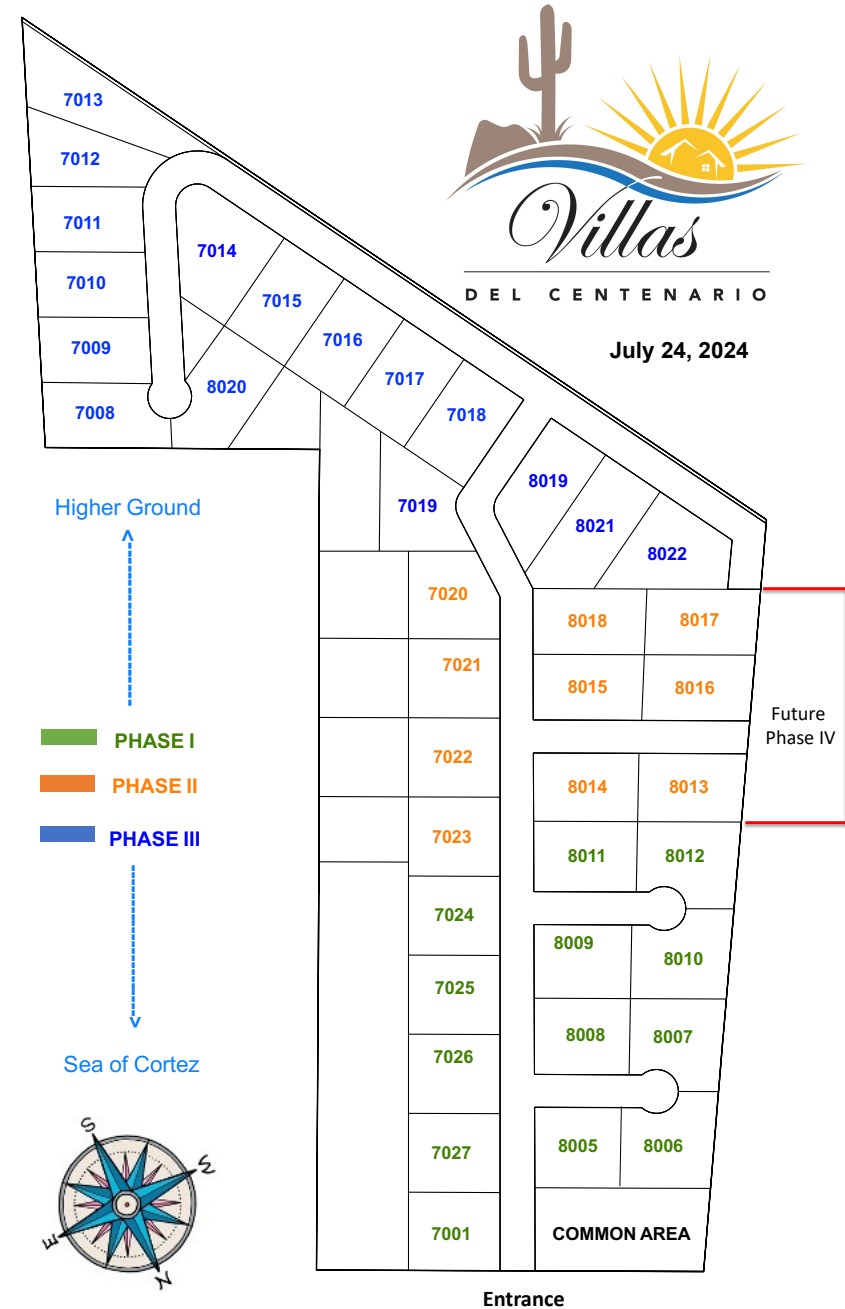

Available Floor Plans

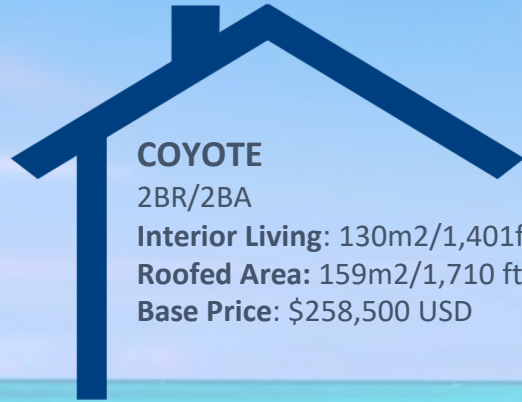

COYOTE

2BR/2BA

Interior Living: 130m²/1,401ft²

Roofed Area: 159m²/1,710 ft²

Base Price: \$258,500 USD



TESORO

2BR/2BA

Interior living: 130m²/1,401 ft²

Roofed Area: 191m²/2,058 ft²

Base Price: \$306,900 USD



COROMUEL

3BR/2BA

Interior living: 151m²/1,628ft²

Roofed Area: 210m²/2,260 ft²

Base Price: \$335,500 USD



BALANDRA

2 master suites/2.5BA

Interior Living: 161m²/1,730ft²

Roofed area: 220m²/2,371.4

Base Price: \$357,500 USD

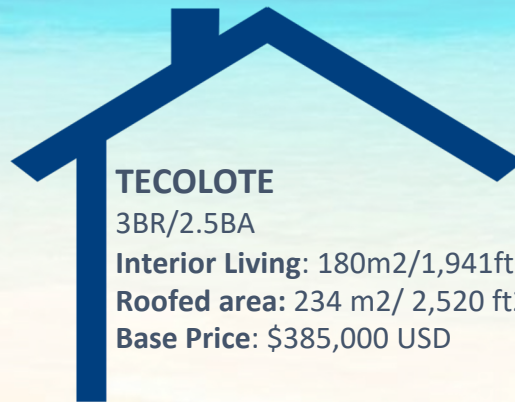

TECOLOTE

3BR/2.5BA

Interior Living: 180m²/1,941ft²

Roofed area: 234 m²/ 2,520 ft²

Base Price: \$385,000 USD

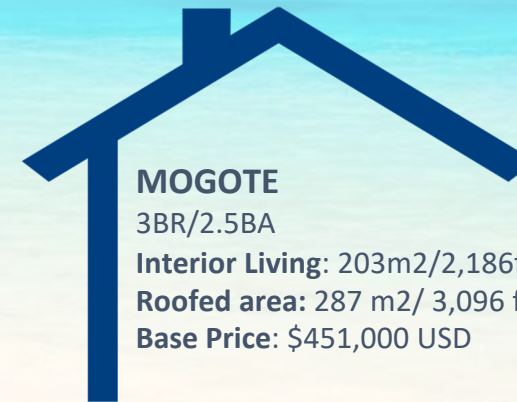

MOGOTE

3BR/2.5BA

Interior Living: 203m²/2,186ft²

Roofed area: 287 m²/ 3,096 ft²

Base Price: \$451,000 USD

Base Price of home does not include lot price or optional upgrades.

PHASE III: Use any of the available plans OR custom design your home, subject to approval by design committee.

Custom homes in Phase III require a \$5,000 architecture fee and a \$350,000 minimum construction spend.

Prices subject to change due to changes in material costs, etc. Final price including any upgrades to be determined at time of construction contract signing.

Pricing the Finished House

- The Total Home Price includes:
 - Lot premium
 - Base home price (includes all interior living and outside covered areas)
 - Retaining wall (based on home footprint and location on a specific lot)
 - Any upgrades and additional terrace
- After a new lot reservation is signed, we:
 - Provide a lot fit drawing of the selected structures on the desired lot
 - Calculate the retaining wall height and cost
 - Adjust the position of the home to optimize view, lot arrangement or budget
 - Present a Construction Worksheet for signature (budgetary quote *)

* Budgetary quote is valid for 30 days; client must sign construction contract prior to expiration of quote.

LOT TBD			
LOT PREMIUM			75,000
MAIN HOUSE (TESORO)			
HOUSE TOTAL FOOTPRINT			2,573.95
	FT2	USD/FT2	TOTAL
CASA TESORO	2,333.95		\$ 306,900.00
POOL 8 x 25	240		\$ 55,000.00
RETAINING WALL	2,573.95	\$ 7.00	\$ 18,017.65
TOTAL HOUSE PRICE			\$ 379,917.65
GARAGE 1 CAR			
GARAGE FOOTPRINT			396.11
	FT2	USD/FT2	TOTAL
GARAGE 10'	396.11		\$ 38,500.00
TOTAL GARAGE			\$ 38,500.00
TOTAL FOOTPRINT			
			2,970.06
HOUSE		\$	379,917.65
GARAGE		\$	38,500.00
TOTAL CONSTRUCTION COST		\$	418,417.65

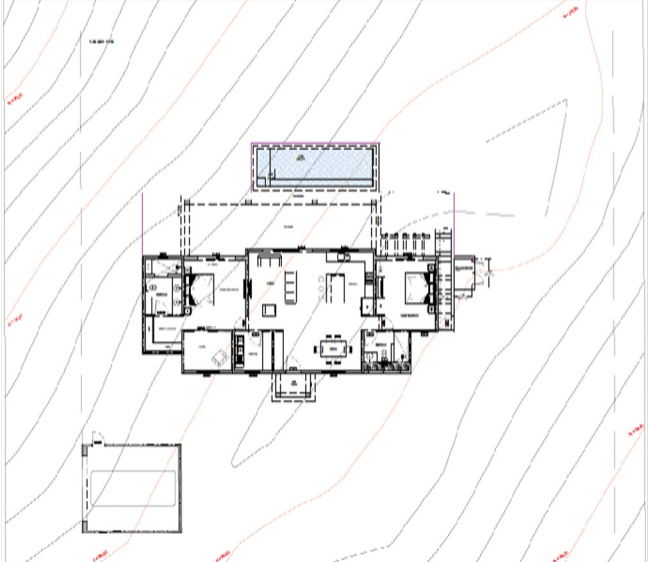

Retaining Walls

- Sloped lots require a retaining wall to support the home correctly
- The cost depends on the slope of the lot and the home footprint
- The cost = the average of the wall height x the footprint in ft²
- The first foot is included in the base price
- Each additional foot adds cost
- Example:
 - Home footprint = 2,500 ft² (incl terraces)
 - Max retaining wall height = 6 ft
 - Average retaining wall = 3 ft (Type C)
 - Retaining wall cost = \$25,000 USD

Retaining walls (price/ft²)

Type A: ≤1'	\$0.00
Type B: 1-2'	\$7.00
Type C: 2-3'	\$10.00
Type D: 3-4'	\$13.00
Type E: 4-5'	\$16.50
Type F: 5-6'	\$20.00

> 6' needs to be calculated

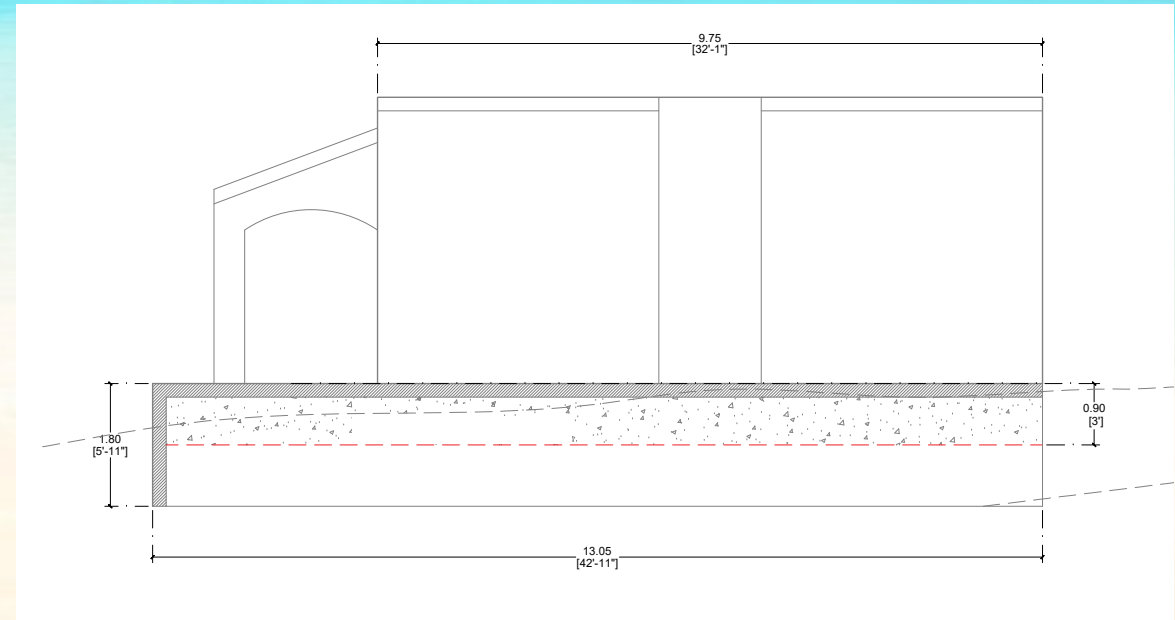

Prices subject to change due to changes in material costs, etc.

Standard Features Included in All Homes

Upgraded interior and exterior finishes are also available upon request, subject to approval by the design committee.



Building Specifications

- Concrete/stucco construction
- Single story
- 10' ceiling height
- Stairs to rooftop deck
- Covered patio (concrete/stucco) with tile roof
- 10,000 liter buried water storage cistern
- 300 liter propane tank
- A/C mini-splits in every room
- City utility hookups (water, electric, telecom)
- 1 year whole-house warranty
- 5 year structural warranty



Interior Finishes

- 18" square or rectangular ceramic floor tile
- Granite countertops & 18" backsplash in kitchen
- Marble counters and 4" backsplash in baths
- Dual vanities in master bath
- Walk-in closet in master BR, built-ins in guest BR
- Alder hardwood cabinetry/woodwork, choice of light, medium, dark stain (painted is an upgrade)
- Choice of 6 paint colors
- Brushed nickel or chrome fixtures
- Recessed LED lights
- Internet/TV conduit in LR and master BR
- 3" aluminum sliding doors/windows, 6mm glass
- Standard ceiling fans in each room



Exterior Finishes

- Cantera molding around parapets
- Covered entry with clay tile roof or natural stone accents (per elevations)
- Solid wood entry door w/ glass insert
- Ceramic tile on patio
- Preparations for outdoor ceiling fans w/ switch
- Exterior storage closet/bodega
- Metal louvered door on bodega
- Rooftop terrace with shade pergola
- Cantera window trim
- Choice of 8 paint colors

Additional Structural Option: Garage

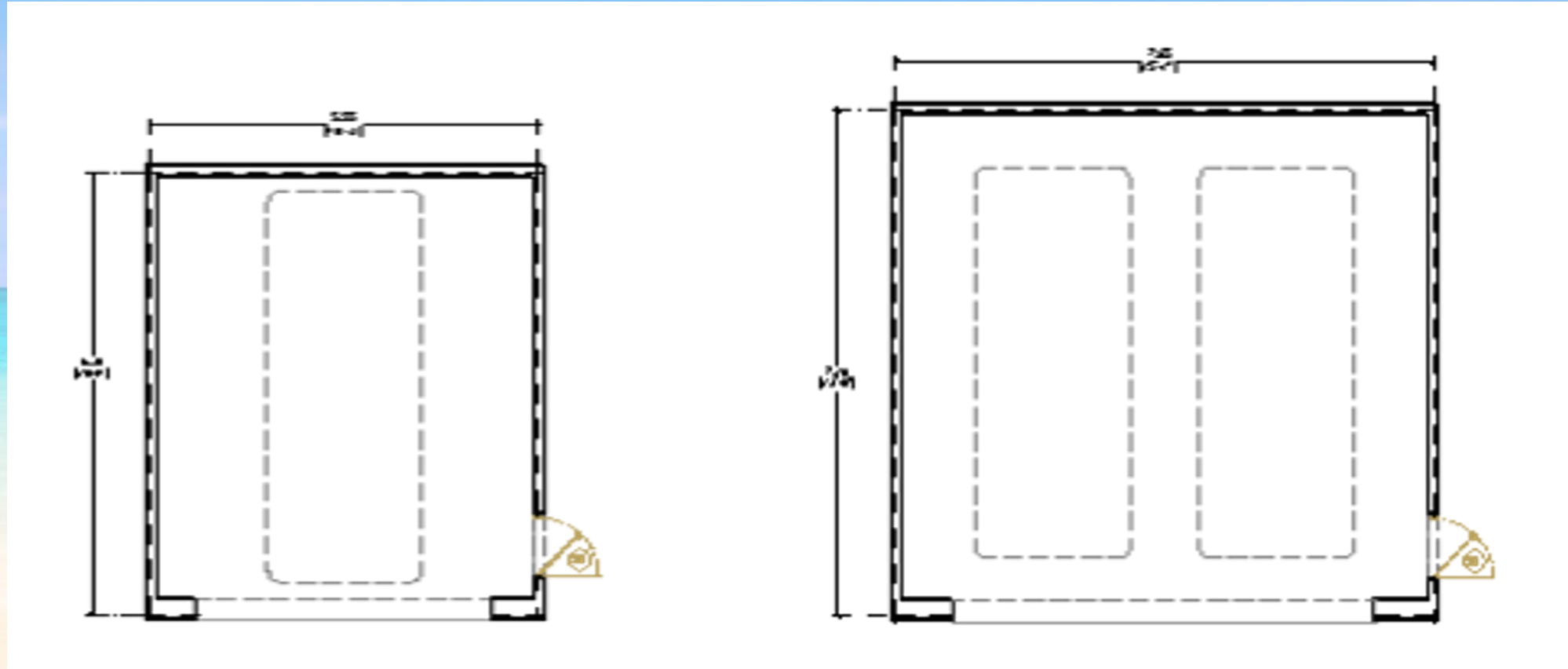

1 Car Garage

37 m² (400 ft²)
\$38,500 USD

2 Car Garage

58 m² (620 ft²)
\$60,500 USD

Prices subject to change due to changes in material costs, etc.

Additional Structural Option: Garage + Casita

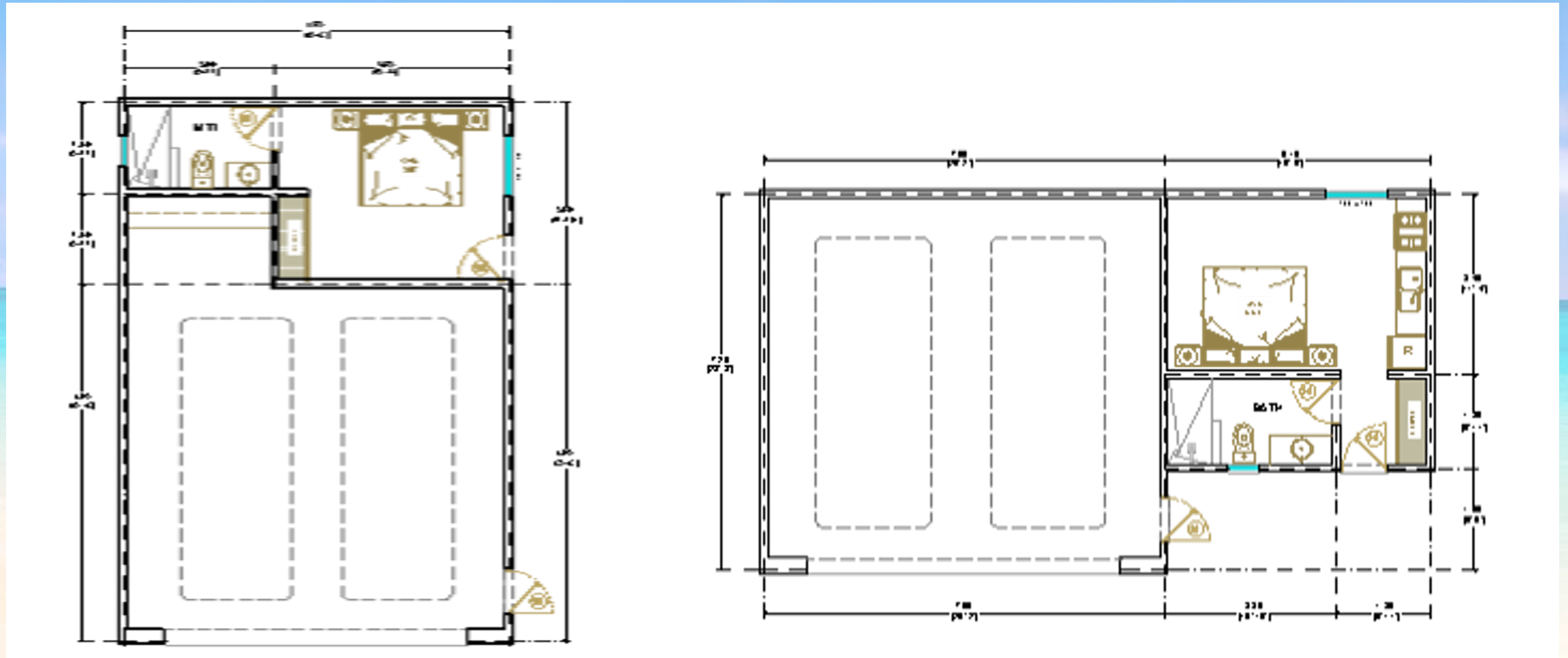

2-Car Garage w/ workshop + Casita

85 m2 (914 ft2)

\$106,500 USD

Prices subject to change due to changes in material costs, etc.

2-Car Garage + Casita w/ kitchenette

84 m2 (900 ft2)

\$115,000 USD

Additional Structural Option: Standard Pool

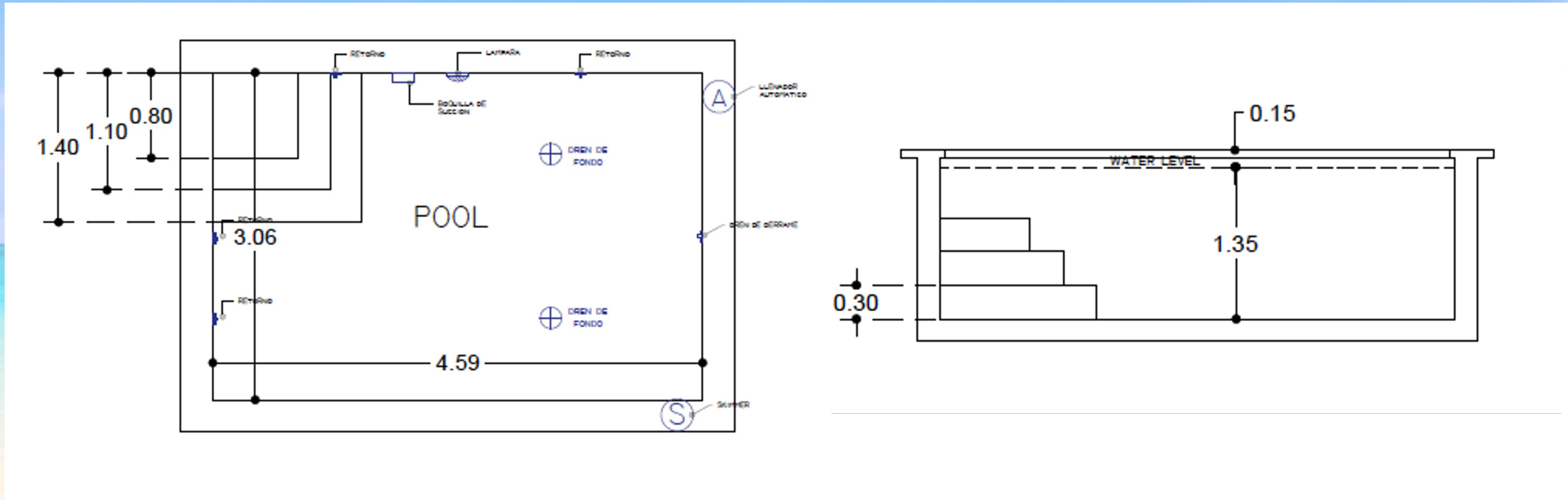

- 10 ft x 15 ft, 5 ft deep with corner stairs
- Tile interior, washed sand coping
- Pump, filter, timer and auto-fill
- \$33,000 USD
- Upgrade to 10 ft x 20 ft pool: \$41,000 USD

Prices subject to change due to changes in material costs, etc.

Additional Structural Option: Pool + SPA

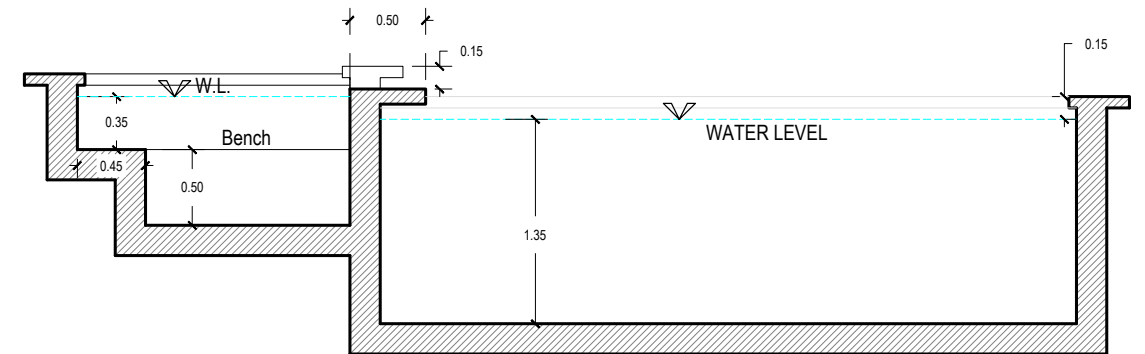
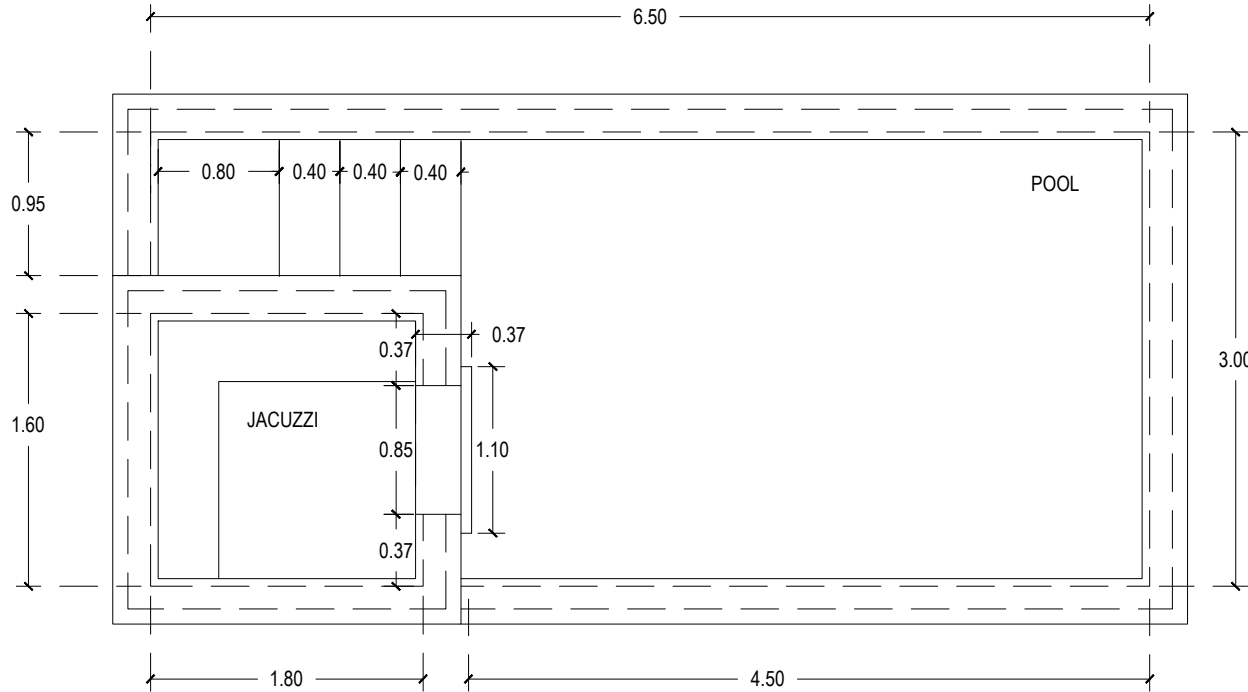

- 10 ft x 21 ft, 5 ft deep w/ SPA
- Corner stairs, seat in SPA
- Tile interior, washed sand coping
- Pump, filter, timer and auto-fill
- \$57,500 USD

Prices subject to change due to changes in material costs, etc.

Building Guidelines



CONSTRUCTION GUIDELINES

- All lots are sold with an attached home plan
- Single story homes only (5 meter max height restriction)
- 25% maximum coverage of lot for AC construction, including garage and patio
- 50% maximum coverage including pool, carport, driveways, and hardscape
- Lot line setbacks: 5 meters from front road, 2 meters from other sides
- Building envelopes in place to ensure maximum views
- Construction must begin within 6 months of Phase opening and within 90 days of contract signing once Phase is open



HOME PLANS AND CHANGES

- Final drawings and plans to be submitted and approved by the buyer and design committee before start of construction
- Exterior structural design, colors and finishes must be approved by design committee
- All interior and exterior selections and finishes must be chosen before start of construction
- All design changes must be approved by buyer and builder
- Changes requested after final plans are approved and selections made are subject to change fees.

Typical Construction Timeline

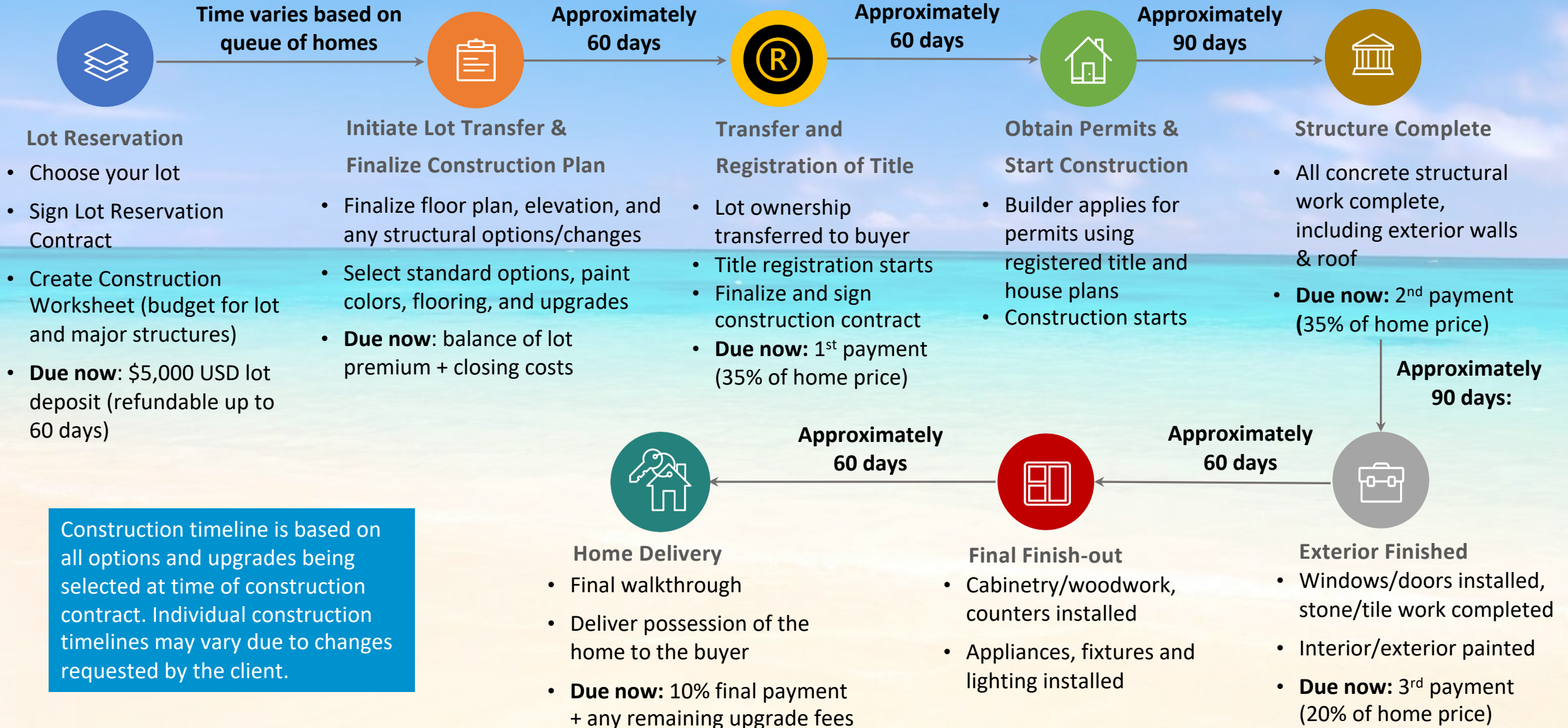

Construction timeline is based on all options and upgrades being selected at time of construction contract. Individual construction timelines may vary due to changes requested by the client.

About the Developer



- Experienced and trusted local architect & builder
- Team of over 100 professionals including building engineers, architects, draftsman, plumbers, electricians, and construction crew
- Bilingual
- Based in El Centenario
- Experience building a wide range of custom homes
- 1 year whole house warranty
- 5 year structural warranty

“Our home is exactly what we wanted and of high quality, and our experience with Baja Custom Homes was very positive. They come highly recommended by us.” — Steve & Cindy Parks

“As an architect and professional builder, Carlos helped take us from the daunting prospect of building a house in Mexico to a dream home in the sun!” — Colin & Cherith Richardson

“Working with Carlos of Baja Custom Homes was a truly positive experience! The project was completed ahead of schedule and on budget! We could not have been happier with the finished product.” — Patricia and Frank Jones

 **BAJA CUSTOM HOMES**

New Homeowner's Package

Homeowners Manual Delivered after final payment:

- Factura (invoice) for the home purchase
- Construction documents (license, terminacion, & registro de obra)
- Final home plans
- All exterior and interior paint and stain colors
- Tile, flooring and natural stone choices
- Appliance manuals
- Garage door openers programmed (if applicable)
- USB drive with:
 - Lot ownership documentation
 - Instructions for transferring utility accounts, paying property taxes and annual fideicomiso fees
 - Contact information for service providers (property management, pool cleaning, etc.)

